

Normal temperature operating conditions

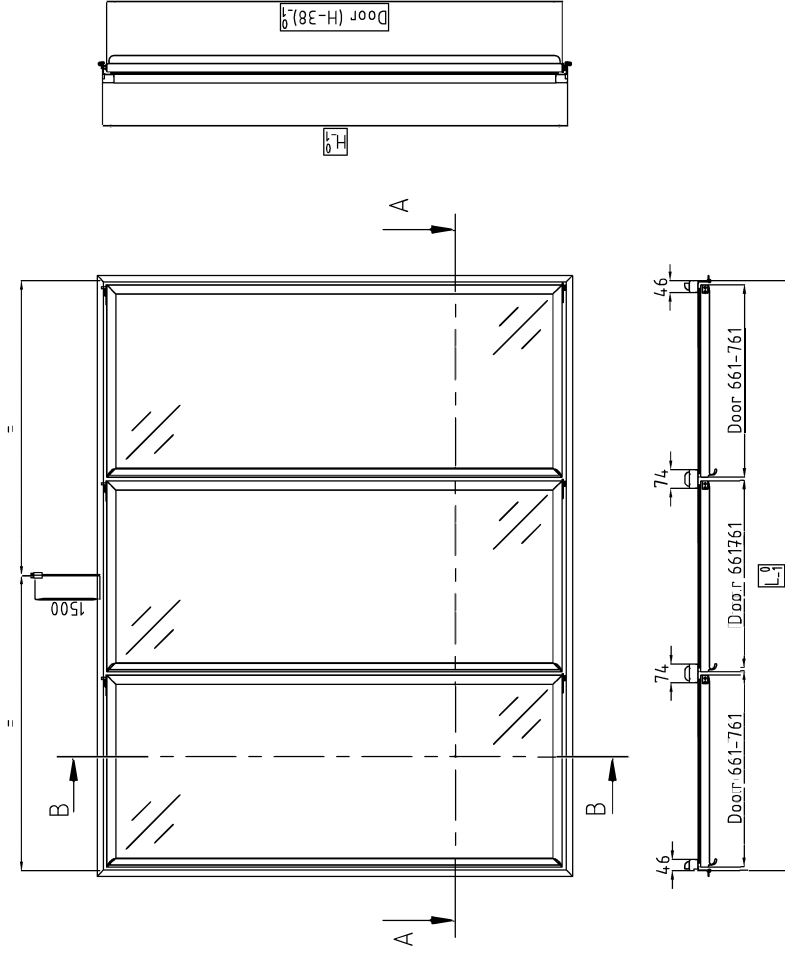

ALUMINIUM FRAMED GLASS DOOR

Exclusive design and full height comfortable grip handle

Left to right hand and vice versa reversible door

Swing door made of double security glass layers according to UNI 12150 standard

Adjustable self-closing action by torsion bar

Manual open wide door lock

STANDARD HEATING MASTER FRAME

Silver satin aluminum insulated by Ral 9005 Pvc covers

Any frame is adapted to receive aluminum framed glass doors by TGD

Any master frame voltage available on demand (standard 220V)

Standard frame prewired. Led application on demand

Standard configuration led prewiring. Led assembly on demand

MASTER FRAME "FILL-IN" DIMENSIONS AND SOURCING REQUIREMENTS

MODEL	1 OPENING		2 OPENINGS		3 OPENINGS		4 OPENINGS		5 OPENINGS	
	LxH	WATT	LxH	WATT	LxH	WATT	LxH	WATT	LxH	WATT
X76	795x1639	56	1564x1639	102	2342x1639	147	3129x1639	193	3898x1639	239
HX76	795x1844	60	1564x1844	108	2342x1844	157	3129x1844	206	3898x1844	254
X66	698x1639	53	1372x1639	95	2046x1639	137	2722x1639	181	3396x1639	223
HX66	698x1844	57	1372x1844	102	2046x1844	148	2722x1844	193	3396x1844	238
Led power W (*)	22 Watt		44 Watt		66 Watt		88 Watt		110 Watt	

(*) only for "Led on board" configuration



Normal temperature operating conditions

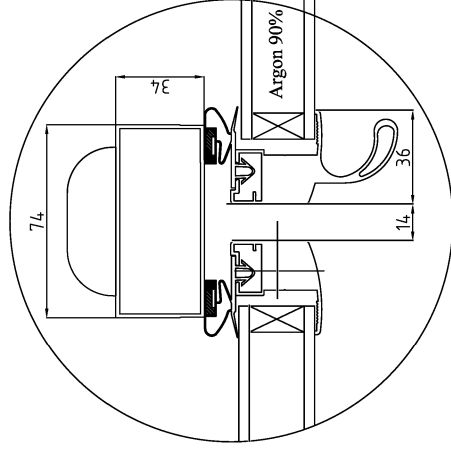
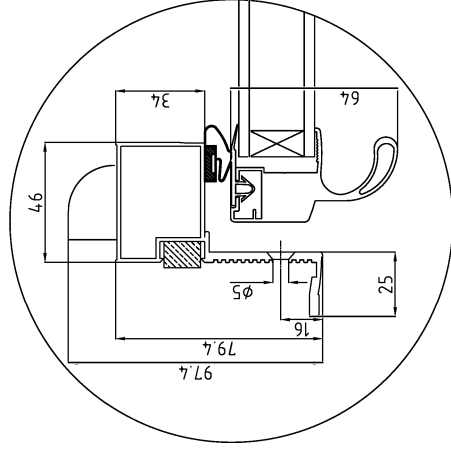
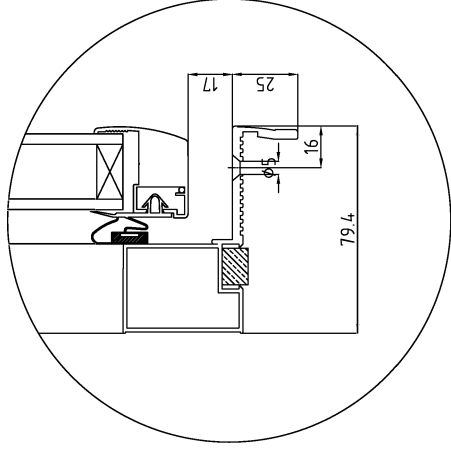
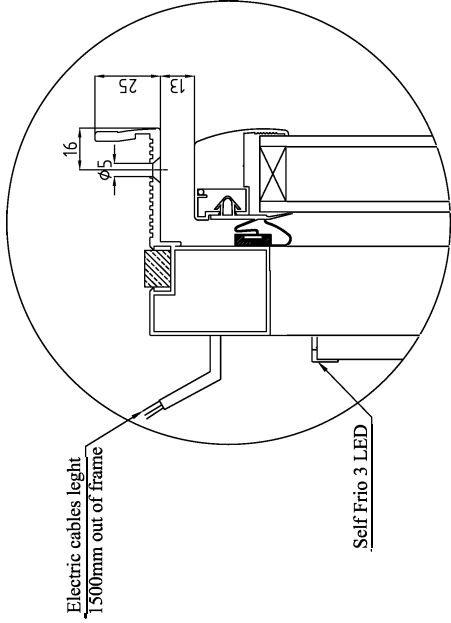

4 Tempered
4 Low E

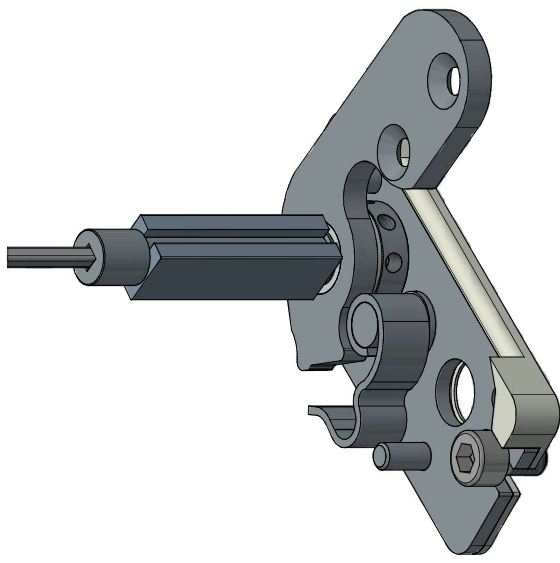

SELF CLOSING ACTION BY TORSION BAR